

SmartCooler®

DATASHEET

cooler than smart

LFM1440: SmartCooler® industrial fan 40x40x20mm

Picture similar to original product:



Drawing similar to original product:

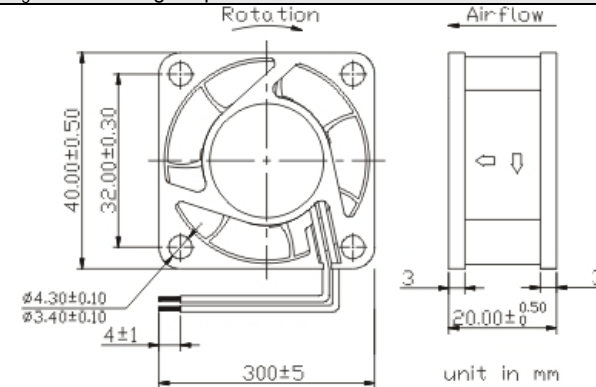

Description:

40x20mm SmartCooler® industrial high end fan made of PBT + 15-30% GF UL94V-0 with very low noise features, minimum vibration and minimum pulsing noise. Rotation from 3.000 up to 9.000 R.P.M.. Airflow from 6.2 – 18.5m³/h. Noise from 12-35dBA.

Product data:

Size (LxWxH):	40x40x20mm	Bearing:	2 ball high tech nano bearing
Hole distance:	32.0mm	Weight:	25 gramm
Hole diameter:	4.3mm	Frame:	4-Hole Frame
Cable:	300mm, UL 1007 AWG 28	Connector:	3-Pin connector 2.54mm
Optional features:	Speed signal	Autorestart	PWM-Signal

Function data:

(V)= 4-Hole, (P)= PWM

Version:	L	E	M	S	H	U	X
R.P.M. +/- 10%:	3.000	4.000	5.000	6.000	7.000	8.000	9.000
Airflow m³/h:	6.200	8.200	10.50	12.50	14.50	16.50	18.50
Airflow cfm:	3.647	4.824	6.176	7.353	8.529	9.706	10.88
Aqmm.	1.115	1.948	3.198	4.449	5.641	7.430	9.220
Noise dbA:	12.00	15.00	19.00	22.00	28.00	32.00	35.00

Electrical data:

Rated current Amp:	0.07A	0.08A	0.09A	0.10A	0.12A	0.15A	0.20A
Rated Power Watt:	0.84W	0.96W	1.08W	1.20W	1.44W	1.80W	2.40W
Starting voltage:	7.00V	5.00V	5.00V	5.00V	5.00V	5.00V	5.00V
Operation voltage:	12.0V	12.0V	12.0V	12.0V	12.0V	12.0V	12.0V

Physical boundaries:

MTBF time about:	<= H = 300K/h, > H = 250K/h	Drop test:	Withstands free body drop of 30cm on a 1m² wooden table with a thickness of 10mm.
Max.environment°C:	70°C	Vib. test:	1.000 R.P.M at 2mm amplitude for 30 Min.

Item:

Safety standards:

Produced after following standards:

CE, TÜV, UL, UR

Item:

Packing:

Size retail Box (LxWxH):

150x100x20mm

Shipping qty. carton:

200 pcs.

Note:

Revision:

Revision: 3.3

Last change: 2008-08-29

SmartCooler GmbH accept no liability for accuracy of the above given information.

Technical changes are subject to alteration.

SmartCooler GmbH - Bernardstraße 5-7 - D-63179 Obertshausen, Germany - EUROPE - Fon +49/6104/600 47-0 - Fax +49/6104/600 47-99

Geschäftsführer - Reinhard Bormuth - Handelsregister Offenbach HRB 11467 - VAT-No.: DE114191179

Internet: <http://www.smartcooler.de> - E-Mail: support@smartcooler.de