

SmartCooler®

DATASHEET

cooler than smart

LFN1130: SmartCooler® industrial fan 30x30x10mm

Picture similar to original product:



Drawing similar to original product:

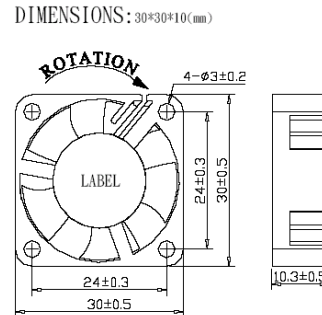

Description:

30x10mm SmartCooler® industrial high end fan made of PBT + 15-30% GF UL94V-0 with very low noise features, minimum vibration and minimum pulsing noise. Rotation from 5.000 up to 11.000 R.P.M.. Airflow from 4.2 – 10.3m³/h. Noise from 9-28dBA.

Product data:

Size (LxWxH):	30x30x10mm	Bearing:	2 ball high tech nano bearing
Hole distance:	24.0mm	Weight:	8 gramm
Hole diameter:	2.5mm	Frame:	4-Hole Frame
Cable:	300mm, UL 1007 AWG 30	Connector:	3-Pin connector 2.54mm
Optional features:	Speed signal	Autorestart	PWM-Signal

Function data:

(V)= 4-Hole, (P)= PWM

Version:	L	E	M	S	H	U	X
R.P.M. +/- 10%:	5.000	6.000	7.000	8.000	9.000	10.000	11.000
Airflow m³/h:	4.200	4.900	5.850	6.700	7.500	8.300	10.300
Airflow cfm:	2.471	2.882	3.441	3.941	4.412	4.882	6.059
Aqmm.	1.470	1.670	1.990	3.200	4.300	5.210	6.680
Noise dbA:	9.000	12.00	15.00	19.00	22.00	25.00	28.00

Electrical data:

Rated current Amp:	0.19A	0.22A	0.24A	0.26A	0.29A	0.36A	0.43A
Rated Power Watt:	0.95W	1.10W	1.20W	1.30W	1.45W	1.80W	2.15W
Starting voltage:	5.00V	5.00V	5.00V	5.00V	5.00V	5.00V	5.00V
Operation voltage:	5.00V	5.00V	5.00V	5.00V	5.00V	5.00V	5.00V

Physical boundaries:

MTBF time about:	<= H = 300K/h, > H = 250K/h	Drop test:	Withstands free body drop of 30cm on a 1m² wooden table with a thickness of 10mm.
Max.environment°C:	70°C	Vib. test:	1.000 R.P.M at 2mm amplitude for 30 Min.

Item:

Safety standards:

Produced after following standards:

CE, TÜV, UL, UR

Item:

Packing:

Size retail Box (LxWxH):

150x100x10mm

Shipping qty. carton:

500 pcs.

Note:

Revision:

Revision: 3.3

Last change: 2008-08-28

SmartCooler GmbH accept no liability for accuracy of the above given information.
Technical changes are subject to alteration.

SmartCooler GmbH - Bernardstraße 5-7 - D-63179 Obertshausen, Germany - EUROPE - Fon +49/6104/600 47-0 - Fax +49/6104/600 47-99
Geschäftsführer - Reinhard Bormuth - Handelsregister Offenbach HRB 11467 - VAT-No.: DE114191179
Internet: <http://www.smartcooler.de> - E-Mail: support@smartcooler.de